



# Quinta Strada

**Design Sergio Bicego**

Anno di produzione 1996

Production year 1996

Restyling 2015

[It] — Progettato nel 1996, il sistema di seduta Quinta Strada, è stato un progetto “pioniere” dello stile moderno. Rigoroso ma flessibile nella componibilità, viene ora rieditato attraverso un restyling attento ai dettagli del nuovo linguaggio contemporaneo. La finitura nero cromo del piede, l'assottigliamento delle staffe di congiunzione, la leggerezza della base e del supporto schienale sono gli eleganti particolari adeguati al moderno living. I diversi elementi della collezione Quinta Strada permettono numerose configurazioni, consentendo composizioni particolarmente interessanti anche nelle situazioni ad angolo. Completamente sfoderabile.

#### Struttura

Base in multistrato e metallo, schienale in legno massello tamburato ricoperti in poliuretano espanso a quote differenziate (75IP e 30P) e rivestiti con velfodera accoppiata a fibra poliestere pressata 300 gr/mq.

Lo schienale è sostenuto da staffe in acciaio black nichel.

#### Piedini

In metallo con finitura black nichel.

#### Imbottitura

I cuscini seduta sono in poliuretano espanso a quote differenziate (35 IP – 35 IM – 25 IM) rivestiti con velfodera accoppiata a resinato 200 gr/mq. I cuscini schiena sono imbottiti con piuma d'oca lavata e sterilizzata mista a fibra di poliestere siliconata rivestita con tessuto di cotone 100% bianco.

[En] — Launched in 1996, the Quinta Strada seating range represented a pioneering design in modern style. Streamlined yet modularly flexible, the range has since then been restyled and re-produced with a sensitivity that is mindful of the new contemporary language. The black chrome finish of the feet, the thinner joining clamps as well as the lightness of the base and back support are elegant touches aligned with modern lifestyle.

The various elements in the Quinta Strada collection allow for numerous configurations and particularly interesting compositions even in corner situations.

Fully removable covers.

#### Structure

Base in plywood and metal, back in honeycomb-paneled solid wood padded with variable-density polyurethane foam (75 IP and 30 IP), covered with velfodera on a polyester fiber 300 gr/sqm. The back is supported by steel brackets black nickel.

#### Feet

Black nickel metal.

#### Padding

The seat cushions are in variable-density polyurethane foam (35 IP – 35 IM – 25 IM), covered in velfodera bonded with resin 200 gr/sqm. The back cushions are padded with washed and sterilized goose down quilted into sections mixed with silicon polyester fiber and covered with 100% white cotton fabric.

## Divani / Sofas

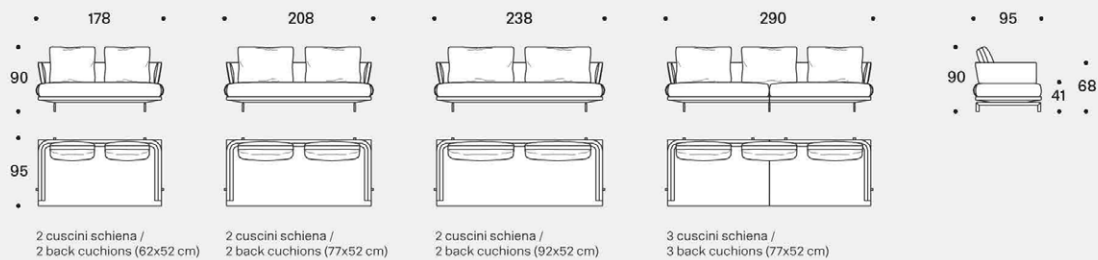

## Laterali DX-SX / Right-left side units

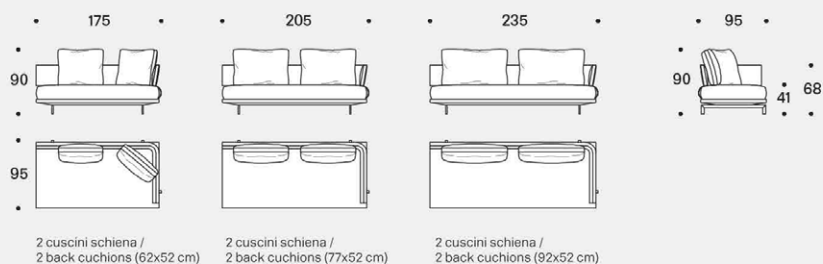

## Terminali angolari DX-SX / Right-left corner end units

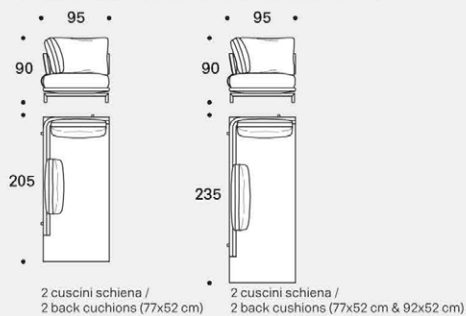

## Penisola DX-SX / Right-left chaise longue

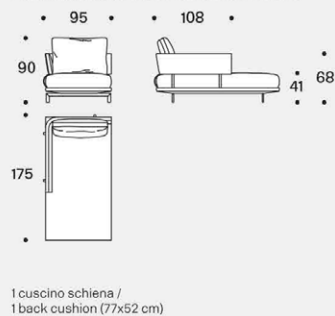

## Pouf

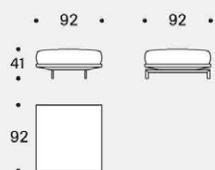

## Cuscino poggiatesta / Lumbar cushion



## Cuscini arredo / Throw cushions



## Laterali DX-SX angolo 22,5° / Right-left 22,5° corner side units

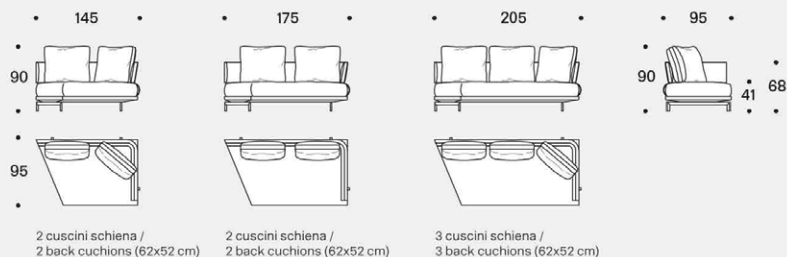

## Terminali DX-SX angolo 22,5° / Right-left 22,5° corner end units

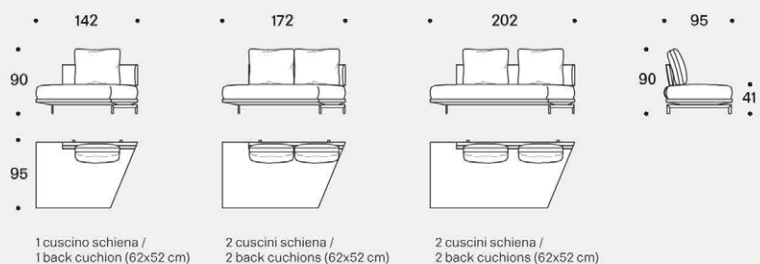

## esempi di composizioni angolo 22,5° / Examples of 22,5° corner compositions

