

gaya

design bolzan LAB



Semplicemente morbido e rilassante, Gaya è il letto che tutti vorremmo trovare alla fine di una giornata densa di impegni. Il suo design senza tempo, fatto di linee semplici e armoniose, suggerisce infinite possibilità di ambientazione: dalle situazioni contemporanee a quelle più classiche. La testiera in due versioni permette un'ulteriore caratterizzazione estetica.

Simply soft and relaxing, Gaya is the bed we would like to find at the end of a busy day. Its timeless design, made of simple and harmonious lines, suggests infinite possibilities of setting: from contemporary situations to more classic ones. The two-version headboard allows further aesthetic characterization.

informazioni tecniche / technical info:

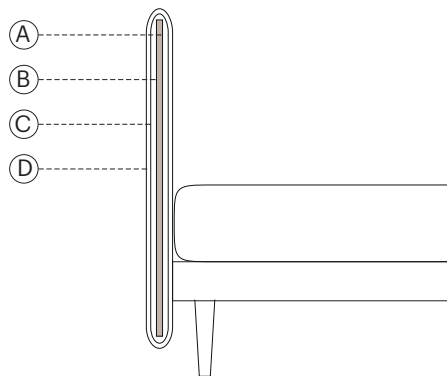

testata / headboard

- A. truciolare 20mm / 20mm chipboard
- B. espanso ignifugo D 25 kg/mc / fire resistant foam D 25 kg/mc
- C. resinato poliestere ignifugo 300g / 300g fire resistant resin polyester fibre
- D. maglia polipropilene 70g / 70g polypropylene mesh

h 9

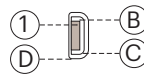

h 20

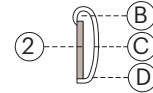

h 29

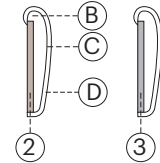

giroletti / bedframes

- 1. MDF 40mm / 40mm MDF
- B. espanso ignifugo D 35 kg/mc / fire resistant foam D 35 kg/mc
- C. resinato poliestere ignifugo 100g / 100g fire resistant resined polyester fiber
- D. maglia polipropilene 70g / 70g polypropylene mesh
- 2. listellare abete 22mm 3 strati / 22mm 3-layer fir blockboard
- 3. estruso in alluminio 22mm / 22 mm extruded aluminum

predisposto per materassi / for mattresses:

90 x 200	35 ³ / ₈ " x 78 ⁶ / ₈ "	137 x 190	54" x 75"	F ull double size
100 x 200	39 ³ / ₈ " x 78 ⁶ / ₈ "	153 x 203	60" x 80"	Q ueen size
120 x 200	47 ² / ₈ " x 78 ⁶ / ₈ "	193 x 203	76" x 80"	K ing size
140 x 200	55 ¹ / ₈ " x 78 ⁶ / ₈ "			
160 x 200	63" x 78 ⁶ / ₈ "			
170 x 200	66 ⁷ / ₈ " x 78 ⁶ / ₈ "			
180 x 200	70 ⁷ / ₈ " x 78 ⁶ / ₈ "			

Gaya Plane / Firwood structure

Standard feet Vasetto - completely removable cover in fabric and non removable headboard cover in leather or eco-leather

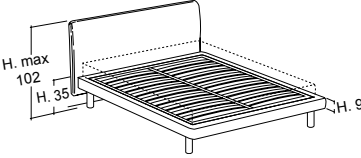
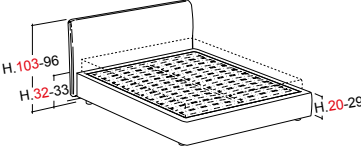
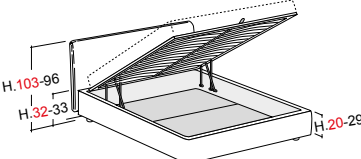
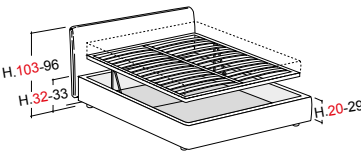
	Mattress	Ext. dimension	Code	D	C	A	Plus	Luxury fabric	Luxury leather	Nuvola fabric	Nuvola leather	TCL	Cover		
													ml	mc	kg
thin base h.9 orthopaedic slatted base included carrying slat 	90x200	106x215	GAS9										5.5	0.3	53
	100x200	116x215	GAC9										6	0.33	57
	120x200	136x215	GAD9										6.5	0.36	64
	135x190	151x205	GAI9										6.9	0.4	66
	137x190 DOUBLE 54X75	151x205	GAE9										6.9	0.4	66
	140x200	156x215	GNU9										7	0.41	68
	150x200	166x215	GNL9										7.3	0.43	78
	153x203 QUEEN 60X80	166x215	GNQ9										7.3	0.43	78
	160x200	176x215	GNM9										7.5	0.45	80
	170x200	186x215	GNF9										7.5	0.47	83
	180x200	196x215	GNG9										8	0.49	86
	190x200	206x215	GNP9										8.5	0.52	90
	193x203 KING 76X80	209x215	GNK9										8.5	0.52	90
		Loose cover		RGN											0.02
rounded base h.20 - rounded base h.29 without slatted base (to choose a slatted base see flap on the right) 	90x200	106x219	GNS29										5.5	0.3	52
	100x200	116x219	GNC29										6	0.31	54
	120x200	136x219	GND29										6.5	0.33	59
	135x190	151x209	GNI29										6.9	0.34	60
	137x190 DOUBLE 54X75	151x209	GNE29										6.9	0.34	60
	140x200	156x219	GNU29										7	0.35	61
	150x200	166x219	GNL29										7.3	0.36	66
	153x203 QUEEN 60X80	169x222	GNQ29										7.3	0.36	66
	160x200	176x219	GNM29										7.5	0.37	67
	170x200	186x219	GNF29										7.5	0.38	70
	180x200	196x219	GNG29										8	0.39	74
	190x200	206x219	GNP29										8.5	0.41	80
	193x203 KING 76X80	209x222	GNK29										8.5	0.41	80
		Loose cover		RGN											0.02
rounded base h.20 - rounded base h.29 w/BOX orthopaedic slatted base included suggested weights for mattresses (see flap on the right) 	90x200	106x219	GNS29B										5.5	0.43	97
	100x200	116x219	GNC29B										6	0.46	105
	120x200	136x219	GND29B										6.5	0.51	118
	135x190	151x209	GNI29B										6.9	0.56	121
	137x190 DOUBLE 54X75	151x209	GNE29B										6.9	0.34	60
	140x200	156x219	GNU29B										7	0.57	122
	150x200	166x219	GNL29B										7.3	0.6	130
	153x203 QUEEN 60X80	169x222	GNQ29B										7.3	0.36	66
	160x200	176x219	GNM29B										7.5	0.62	132
	170x200	186x219	GNF29B										7.5	0.65	138
	180x200	196x219	GNG29B										8	0.67	144
	190x200	206x219	GNP29B										9	0.7	152
	193x203 KING 76X80	209x222	GNK29B										8.5	0.41	80
	available inside height in Box 12-18cm	Loose cover		RGN											0.02
rounded base h.20 - rounded base h.29 w/easy-up BOX orthopaedic slatted base included suggested weights for mattresses (see flap on the right) 	90x200	106x219	GNS29BE										5.5	0.47	107
	100x200	116x219	GNC29BE										6	0.5	115
	120x200	136x219	GND29BE										6.5	0.55	128
	135x190	151x209	GNI29BE										6.9	0.6	131
	137x190 DOUBLE 54X75	151x209	GNE29BE										6.9	0.56	121
	140x200	156x219	GNU29BE										7	0.61	132
	150x200	166x219	GNL29BE										7.3	0.64	139
	153x203 QUEEN 60X80	169x222	GNQ29BE										7.3	0.6	130
	160x200	176x219	GNM29BE										7.5	0.66	142
	170x200	186x219	GNF29BE										7.5	0.69	148
	180x200	196x219	GNG29BE										8	0.71	154
	190x200	206x219	GNP29BE										8.5	0.74	162
	193x203 KING 76X80	209x222	GNK29BE										9	0.7	152
	available inside height in Box 12-18cm	Loose cover		RGN										48.6	0.02

Gaya Plane / Aluminum structure

Standard feet Vasetto - completely removable cover in fabric and non removable headboard cover in leather or ecoleather

	Mattress	Ext. dimension	Code	D	C	A	Plus	Luxury fabric	Luxury leather	Nuvola fabric	Nuvola leather	TCL	Cover			
													ml	mc	kg	
rounded base h.29 without slatted base (to choose a slatted base see flap on the right)	90x200	106x219	GNS29A										5.5	0.3	53	
	100x200	116x219	GNC29A										6	0.31	55	
	120x200	136x219	GND29A										6.5	0.33	60	
	135x190	151x209	GNI29A										6.9	0.34	62	
	137x190 DOUBLE 54X75°	151x209	GNE29A										6.9	0.34	62	
	140x200	156x219	GNU29A										7	0.35	63	
	150x200	166x219	GNL29A										7.3	0.36	69	
	153x203 QUEEN 60X80°	169x222	GNQ29A										7.3	0.36	69	
	160x200	176x219	GNM29A										7.5	0.37	70	
	170x200	186x219	GNF29A										7.5	0.38	73	
	180x200	196x219	GNG29A										8	0.39	78	
	190x200	206x219	GNP29A										8.5	0.41	85	
	193x203 KING 76X80°	209x222	GNK29A										8.5	0.41	85	
		Loose cover		RGNA											0.02	8
	rounded base h.29 w/BOX orthopaedic slatted base included suggested weights for mattresses (see flap on the right)	90x200	106x219	GNS29BA										5.5	0.43	98
100x200		116x219	GNC29BA										6	0.46	106	
120x200		136x219	GND29BA										6.5	0.51	119	
135x190		151x209	GNI29BA										6.9	0.56	123	
137x190 DOUBLE 54X75°		151x209	GNE29BA										6.9	0.56	123	
140x200		156x219	GNU29BA										7	0.57	124	
150x200		166x219	GNL29BA										7.3	0.6	133	
153x203 QUEEN 60X80°		169x222	GNQ29BA										7.3	0.6	133	
160x200		176x219	GNM29BA										7.5	0.62	135	
170x200		186x219	GNF29BA										7.5	0.65	141	
180x200		196x219	GNG29BA										8	0.67	148	
190x200		206x219	GNP29BA										9	0.7	157	
193x203 KING 76X80°		209x222	GNK29BA										9	0.7	157	
		Loose cover		RGNA											0.02	8
rounded base h.29 w/easy-up BOX orthopaedic slatted base included suggested weights for mattresses (see flap on the right)		90x200	106x219	GNS29BEA										5.5	0.47	108
	100x200	116x219	GNC29BEA										6	0.5	116	
	120x200	136x219	GND29BEA										6.5	0.55	129	
	135x190	151x209	GNI29BEA										6.9	0.6	133	
	137x190 DOUBLE 54X75°	151x209	GNE29BEA										6.9	0.6	133	
	140x200	156x219	GNU29BEA										7	0.61	134	
	150x200	166x219	GNL29BEA										7.3	0.64	142	
	153x203 QUEEN 60X80°	169x222	GNQ29BEA										7.3	0.64	142	
	160x200	176x219	GNM29BEA										7.5	0.66	145	
	170x200	186x219	GNF29BEA										7.5	0.69	151	
	180x200	196x219	GNG29BEA										8	0.71	158	
	190x200	206x219	GNP29BEA										8.5	0.74	167	
	193x203 KING 76X80°	209x222	GNK29BEA										8.5	0.74	167	
		Loose cover		RGNA											0.02	8
	rounded base h.29 w/HANDS FREE BOX orthopaedic slatted base included Specify mattress weight (see flap on the right)	150x200	166x222	GNL29BHF										7.3	0.64	139
153x203 QUEEN 60X80°		169x225	GNQ29BHF										7.3	0.64	139	
160x200		176x222	GNM29BHF										7.5	0.66	141	
170x200		186x222	GNF29BHF										7.5	0.69	147	
180x200		196x222	GNG29BHF										8	0.71	155	
190x200		206x222	GNP29BHF										9	0.74	165	
193x203 KING 76X80°		209x225	GNK29BHF										9	0.74	165	
		Loose cover		RGNHF											0.02	8

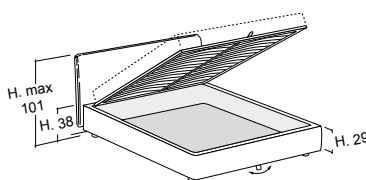
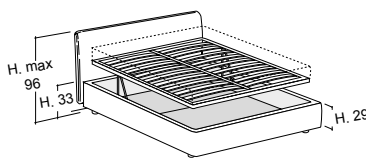
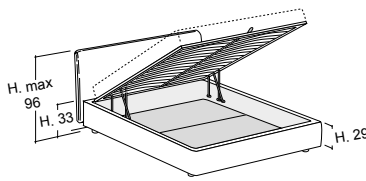
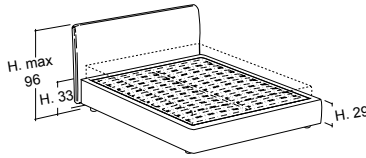

Gaya Wave / Firwood structure

Standard feet Vasetto - completely removable cover

	Mattress	Ext. dimension	Code	D	C	A	Plus	Luxury fabric	Luxury leather	Nuvola fabric	Nuvola leather	TCL	Cover		
													ml	mc	kg
thin base h.9 orthopaedic slatted base included carrying slat	90x200	116x215	HAS9										4.5	0.3	55
	100x200	126x215	HAC9										4.8	0.33	59
	120x200	146x215	HAD9										5	0.36	66
	135x190	161x205	HAI9										5.2	0.4	70
	137x190 DOUBLE 54x75"	161x205	HAE9										5.2	0.4	70
	140x200	166x215	HAU9										5.3	0.41	71
	150x200	176x215	HAL9										5.4	0.43	82
	153x203 QUEEN 60x80"	176x215	HAQ9										5.4	0.43	82
	160x200	186x215	HAM9										5.5	0.45	82
	170x200	196x215	HAF9										5.8	0.47	85
	180x200	206x215	HAG9										6	0.49	88
	190x200	216x215	HAP9										6.5	0.52	92
	193x203 KING 76x80"	219x215	HAK9										6.5	0.52	92
		Loose cover		RHA											0.02
rounded base h.20 - rounded base h.29 without slatted base (to choose a slatted base see flap on the right)	90x200	116x219	HAS29										4.5	0.36	54
	100x200	126x219	HAC29										4.8	0.37	57
	120x200	146x219	HAD29										5	0.39	63
	135x190	161x209	HAI29										5.2	0.4	66
	137x190 DOUBLE 54x75"	161x209	HAE29										5.2	0.4	66
	140x200	166x219	HAU29										5.3	0.41	67
	150x200	176x219	HAL29										5.4	0.42	70
	153x203 QUEEN 60x80"	179x222	HAQ29										5.4	0.42	70
	160x200	186x219	HAM29										5.5	0.43	72
	170x200	196x219	HAF29										5.8	0.44	76
	180x200	206x219	HAG29										6	0.46	81
	190x200	216x219	HAP29										6.5	0.49	87
	193x203 KING 76x80"	219x222	HAK29										6.5	0.49	87
		Loose cover		RHA											0.02
rounded base h.20 - rounded base h.29 w/BOX orthopaedic slatted base included suggested weights for mattresses (see flap on the right)	90x200	116x219	HAS29B										4.5	0.46	94
	100x200	126x219	HAC29B										4.8	0.49	103
	120x200	146x219	HAD29B										5	0.55	114
	135x190	161x209	HAI29B										5.2	0.59	117
	137x190 DOUBLE 54x75"	161x209	HAE29B										5.2	0.59	117
	140x200	166x219	HAU29B										5.3	0.61	118
	150x200	176x219	HAL29B										5.4	0.65	124
	153x203 QUEEN 60x80"	179x222	HAQ29B										5.4	0.65	124
	160x200	186x219	HAM29B										5.5	0.67	127
	170x200	196x219	HAF29B										5.8	0.69	134
	180x200	206x219	HAG29B										6	0.72	141
	190x200	216x219	HAP29B										6.5	0.76	150
	193x203 KING 76x80"	219x222	HAK29B										6.5	0.76	150
		Loose cover		RHA											0.02
rounded base h.20 - rounded base h.29 w/easy-up BOX orthopaedic slatted base included suggested weights for mattresses (see flap on the right)	90x200	116x219	HAS29BE										4.5	0.5	104
	100x200	126x219	HAC29BE										4.8	0.53	113
	120x200	146x219	HAD29BE										5	0.59	124
	135x190	161x209	HAI29BE										5.2	0.63	127
	137x190 DOUBLE 54x75"	161x209	HAE29BE										5.2	0.63	127
	140x200	166x219	HAU29BE										5.3	0.65	128
	150x200	176x219	HAL29BE										5.4	0.69	134
	153x203 QUEEN 60x80"	179x222	HAQ29BE										5.4	0.69	134
	160x200	186x219	HAM29BE										5.5	0.71	137
	170x200	196x219	HAF29BE										5.8	0.73	144
	180x200	206x219	HAG29BE										6	0.76	151
	190x200	216x219	HAP29BE										6.5	0.8	160
	193x203 KING 76x80"	219x222	HAK29BE										6.5	0.8	160
		Loose cover		RHA											0.02

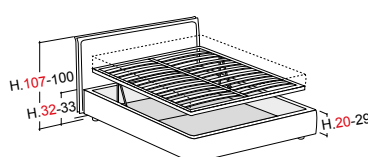
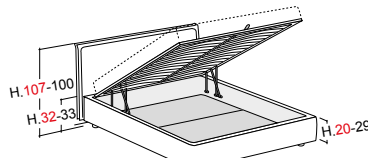
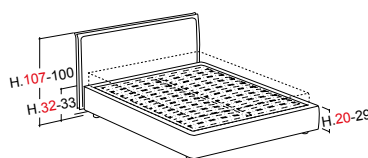
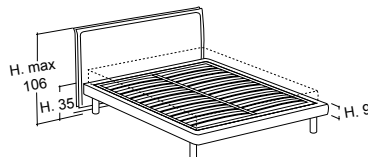

available inside height in Box 12-18cm

available inside height in Box 12-18cm

Gaya Wave / Aluminum structure

Standard feet Vasetto - completely removable cover

	Mattress	Ext. dimension	Code	D	C	A	Plus	Luxury fabric	Luxury leather	Nuvola fabric	Nuvola leather	TCL	Cover			
													ml	mc	kg	
rounded base h.29 without slatted base (to choose a slatted base see flap on the right)	90x200	116x219	HAS29A										5.5	0.36	55	
	100x200	126x219	HAC29A										6	0.37	58	
	120x200	146x219	HAD29A										6.5	0.39	61	
	135x190	161x209	HAI29A										6.9	0.4	66	
	137x190 DOUBLE 54X75°	161x209	HAE29A										6.9	0.4	66	
	140x200	166x219	HAU29A										7	0.41	67	
	150x200	176x219	HAL29A										7.3	0.42	73	
	153x203 QUEEN 60X80°	179x222	HAQ29A											7.3	0.42	73
	160x200	186x219	HAM29A											7.5	0.43	75
	170x200	196x219	HAF29A											7.5	0.44	79
	180x200	206x219	HAG29A											8	0.46	85
	190x200	216x219	HAP29A											8.5	0.49	92
	193x203 KING 76X80°	219x222	HAK29A											8.5	0.49	92
		Loose cover		RHAA										48.6	0.02	8
	rounded base h.29 w/BOX orthopaedic slatted base included suggested weights for mattresses (see flap on the right)	90x200	116x219	HAS29BA										5.5	0.46	100
100x200		126x219	HAC29BA										6	0.49	109	
120x200		146x219	HAD29BA										6.5	0.55	120	
135x190		161x209	HAI29BA										6.9	0.59	127	
137x190 DOUBLE 54X75°		161x209	HAE29BA										6.9	0.59	127	
140x200		166x219	HAU29BA										7	0.61	128	
150x200		176x219	HAL29BA										7.3	0.65	137	
153x203 QUEEN 60X80°		179x222	HAQ29BA											7.3	0.65	137
160x200		186x219	HAM29BA											7.5	0.67	140
170x200		196x219	HAF29BA											7.5	0.69	147
180x200		206x219	HAG29BA											8	0.72	155
190x200		216x219	HAP29BA											9	0.76	165
193x203 KING 76X80°		219x222	HAK29BA											9	0.76	165
		Loose cover		RHAA										48.6	0.02	8
rounded base h.29 w/easy-up BOX orthopaedic slatted base included suggested weights for mattresses (see flap on the right)		90x200	116x219	HAS29BEA										5.5	0.5	110
	100x200	126x219	HAC29BEA										6	0.53	119	
	120x200	146x219	HAD29BEA										6.5	0.59	130	
	135x190	161x209	HAI29BEA										6.9	0.63	137	
	137x190 DOUBLE 54X75°	161x209	HAE29BEA										6.9	0.63	137	
	140x200	166x219	HAU29BEA										7	0.65	138	
	150x200	176x219	HAL29BEA										7.3	0.69	147	
	153x203 QUEEN 60X80°	179x222	HAQ29BEA											7.3	0.69	147
	160x200	186x219	HAM29BEA											7.5	0.71	150
	170x200	196x219	HAF29BEA											7.5	0.73	157
	180x200	206x219	HAG29BEA											8	0.76	165
	190x200	216x219	HAP29BEA											8.5	0.8	175
	193x203 KING 76X80°	219x222	HAK29BEA											8.5	0.8	175
		Loose cover		RHAA										48.6	0.02	8
	rounded base h.29 w/HANDS FREE BOX orthopaedic slatted base included Specify mattress weight (see flap on the right)	150x200	176x222	HAL29BHF										7.3	0.69	143
153x203 QUEEN 60X80°		179x225	HAQ29BHF										7.3	0.69	143	
160x200		186x222	HAM29BHF										7.5	0.71	146	
170x200		196x222	HAF29BHF										7.5	0.73	153	
180x200		206x222	HAG29BHF										8	0.76	162	
190x200		216x222	HAP29BHF										9	0.78	173	
193x203 KING 76X80°		219x225	HAK29BHF										9	0.78	173	
		Loose cover		RHAHF										0.02		8

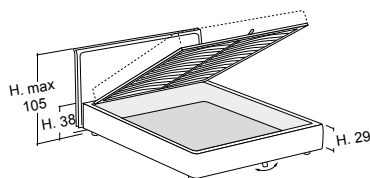
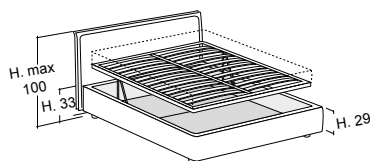
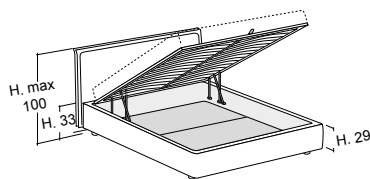
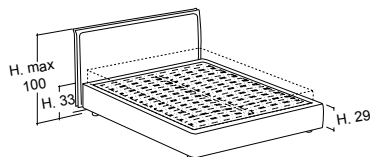

GIROLETTI E PIEDINI / BEDFRAMES AND FEET

pieдини in legno / wooden feet:

pieдини realizzati in legno di frassino con possibilità di essere tinti, verniciati ral o foderati in tessuto a scelta.

ash wood legs with the possibility of being dyed, RAL varnished or lined with fabric (of your choice)

pieдини in metallo / metal feet:

pieдини realizzati in metallo con possibilità di essere verniciati effetto ottone o colori ral.

metal legs with the possibility of being painted in brass effect or RAL varnished.

bedframe h.9 cm



cilindro

H 26 cm 10²/₈"



vasetto

H 26 cm 10²/₈"



vasetto inclinato

H 26 cm 10²/₈"



tubino

H 26 cm 10²/₈"



lamina

H 26 cm 10²/₈"



arco

H 26 cm 10²/₈"

bedframe h.20 cm



cilindro

H 12,5 cm 4⁷/₈"



vasetto

H 12,5 cm 4⁷/₈"



tubino

H 12,5 cm 4⁷/₈"



lamina

H 15 cm 5⁷/₈"

bedframe h.29 cm



vasetto h. 4cm

H 4 cm 1⁵/₈"



vasetto h. 9-12,5 cm

H 9 cm 3⁴/₈"

H 12,5 cm 4⁷/₈"



cipolla

H 8 cm 3¹/₈"

finiture legno tinto / lacquered wood finishes:



noce / walnut



ciliegio / cherry



rovere / oak



wengè

finiture metallo / metal finishes:



ottone satinato /
brushed brass

finiture laccati ral / ral lacquered finishes:



bianco / white
RAL 9010



nero / black
RAL 9011



grigio / grey
RAL 7044



marrone / brown
RAL 8019



rosso / red
RAL 3005



verde / green
RAL 6020



blu / blue
RAL 5008

h. 20-29 SISTEMA CONTENITORE / BOX SYSTEM



box

BOX

apertura basic del box grazie ad un semplice sistema a leva / basic opening of storage box thanks to a simple lever system

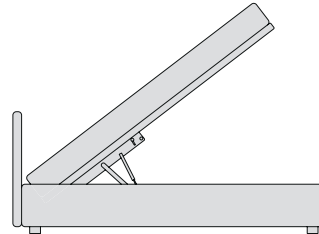

-  interno in legno
-  interno in alluminio only for h29cm

HANDS-FREE solo per h.29 cm / only for h.29cm

apertura del box senza l'uso delle mani e grazie al box completamente in alluminio è privo di pistoncini a vista / The mechanism allows to open the storage box without hands, and thanks to its aluminum structure, the storage box has inner pistons, thus maintaining a top-notch design

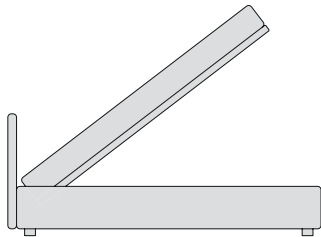

-  interno in alluminio only for h29cm

EASY UP

grazie al movimento che mantiene la rete all'interno dello spazio occupato dal letto, ottimizza lo spazio all'interno della stanza / mechanism optimizes the space inside the room thanks to its movement that keeps the slatted base within the space occupied by the bed

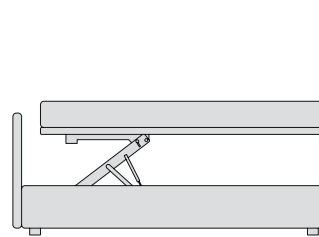

-  interno in legno
-  interno in alluminio only for h29cm

h. 20-29 INCASSO MATERASSO / MATTRESS RECESS

La struttura dei letti Bolzan permette di soddisfare le diverse esigenze di progettazione: l'incasso del materasso nella struttura del letto è personalizzabile in 7 altezze diverse. Non disponibile per le basi con box.

Bolzan beds' structure allows you to meet different design needs: the mattress recess in the bed's structure is customizable in 7 different heights. It is not available for bases with box.

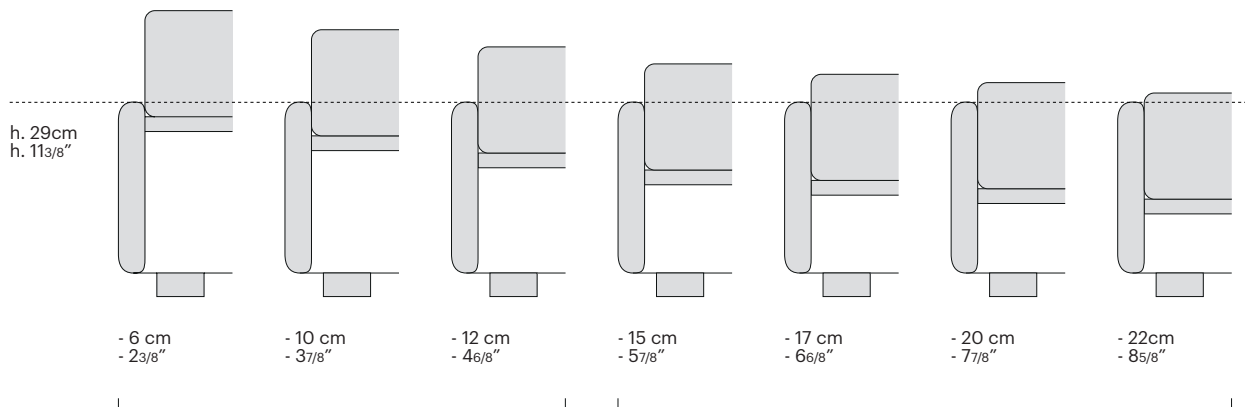

ribassamento disponibile per giroletto h. 20 e h. 29 cm / mattress recess available for h. 20 and h. 29 cm bedframes

ribassamento disponibile solo per giroletto h. 29 cm / mattress recess available for h. 29 cm bedframe

INFORMAZIONI SUI MATERIALI

Legno

Tutto il legname proviene da produttori certificati PEFC/CTM, ciò significa che il legno proviene da piantagioni di riforestazione, dove ogni pianta utilizzata viene sostituita da una nuova per non distruggere l'ambiente anzi aumentandone l'apporto di ossigeno all'interno dell'atmosfera.

Bolzan Letti, da sempre particolarmente attenta alla politica ambientale e al perseguimento di nuovi obiettivi di miglioramento del proprio prodotto anche e soprattutto in termini di tutela della salute delle persone, ha già scelto di andare oltre, acquistando solo pannelli compensati certificati CARB e CARB2, destinati a tutta la produzione e non solo ai prodotti da immettere sul mercato Usa.

Alluminio 100% riciclabile

Resistente, leggero e durevole, l'alluminio non si altera nel tempo e può essere fuso e riciclato all'infinito, con un ridotto consumo di energia, senza perdere le sue caratteristiche originali. Ecco perché si può definire un materiale eco-sostenibile per eccellenza, a vantaggio della qualità della vita di oggi e di domani.

Gommapiuma e rivestimento interno

Dal sapiente taglio dei blocchi di gomma nascono tutte le imbottiture. Nelle imbottiture è fondamentale saper scegliere le varie densità di gomma in quanto ogni parte del letto risponde ad esigenze estetiche-funzionali diverse. L'uso di poliuretano espanso ad alta densità ed indeformabile garantisce comfort e durata. Tutti gli imbottiti vengono foderati con dacron accoppiato a velfodera resistente alla luce ed ignifuga, secondo le normative standard mondiali.

Materiali riciclati/riciclabili

È stata posta attenzione anche alle imbottiture, realizzate prevalentemente in schiumati riciclabili. Il poliuretano espanso flessibile, comunemente noto come "gommapiuma", rappresenta l'imbottitura in assoluto più utilizzata, grazie alla vasta gamma disponibile per formati e densità. Le rimanenze vengono riconvertite in lastre di agglomerato espanso che vengono interamente riutilizzate all'interno della produzione annullando gli scarti di materia prima.

Colle atossiche

La colla utilizzata è a base d'acqua per ridurre la presenza di solventi sintetici. I vantaggi dell'utilizzo della vernice all'acqua, si esprimono nella grande sostenibilità e limitato impatto ambientale nell'uso di questo prodotto. Grazie all'utilizzo delle vernici e colle all'acqua è infatti possibile ridurre del 95 per cento le emissioni nell'ambiente di composti organici volatili (COV), diversamente dall'impiego di comuni vernici a solvente. Altro vantaggio relativo l'utilizzo di colle ad acqua, è che questi prodotti sono completamente inodore, non infiammabili e caratterizzati da livelli di tossicità estremamente limitati.

Materiali alternativi / cocco

La ricerca continua e la volontà di innovare in maniera sostenibile ha portato l'azienda a utilizzare materiali alternativi come le lastre di cocco che compongono l'imbottitura dei letti. La fibra di cocco viene raccolta dall'omonimo albero in India, Sri Lanka, Indonesia, Brasile. Le fibre di cocco vengono impregnate con lattice naturale: l'amalgama risultante (il cocco gommato) viene vulcanizzato e successivamente sagomato in lastre di varie formati, spessori e densità. È possibile inoltre avere lastre sagomate con canali trasversali atti a favorire un'ulteriore traspirabilità. Rispetto ad altri materiali, l'impiego del cocco nella lavorazione di imbottiti ha il vantaggio, di un facile e rapido confezionamento del prodotto, dato che le lastre in cocco gommato possono essere incollate, graffettate e cucite mantenendo inalterata la loro caratteristica principale che è la robustezza: non si sfaldano nel tempo, non provocano polvere, non assorbono umidità. Oltre a ciò si presta ad essere utilizzato all'interno di poltrone e materassi raggiungendo il 20% di peso in meno.

Materiali alternativi / ovatta

Lovatta contribuisce a garantire il benessere della persona durante il riposo, restando a contatto con il corpo insieme al tessuto e determinando una piacevole sensazione di comfort. Bolzan Letti dedica a questo materiale la stessa attenzione che rivolge alla costruzione delle strutture interne. Lovatta di lana ha una microstruttura formata da una fitta rete di fibre che dona all'imbottitura naturali doti di traspirabilità, indeformabilità e durata nel tempo. Lovatta di poliestere è un materiale non solo soffice, indeformabile, resistente, ipoallergenico, inattaccabile da acari e muffe e idrorepellente, ma anche ecosostenibile. È infatti composta al 75% da fibre provenienti dal riciclo di bottiglie di plastica e quindi è a sua volta facilmente riciclabile. Inoltre è certificata Oeko-Tex Classe 1 e ciò garantisce l'assenza di sostanze nocive.

Tessuti

I tessuti sostenibili sono il risultato di processi produttivi industriali ecocompatibili, basati sulla riduzione di consumi energetici, sull'utilizzo di fonti di materie prime rinnovabili, sull'ottimizzazione della catena produttiva capace di ridurre l'impiego di prodotti chimici anche grazie a nuove soluzioni basate sulla biochimica e all'utilizzo delle biotecnologie.

- **Tessuti FSC** Numerosi tessuti della collezione Bolzan Letti sono marchiati FSC. Questi tessuti sono più rispettosi dell'ambiente rispetto alle fibre sintetiche o al cotone in quanto le fibre di cellulosa di cui sono fatti provengono da foreste gestite in maniera corretta e sostenibile.

- **Tessuti OEKO** L'Oeko-Tex Standard 100 è uno standard unico di certificazione e controllo nel settore delle materie prime tessili, dei semilavorati e dei prodotti finiti in tutte le fasi di lavorazione, che permette di identificare quei prodotti che non presentano alcun rischio per la salute del consumatore.

- **Tessuti PEFC** Il marchio PEFC significa che proviene da una foresta certificata (ovviamente, solo il materiale di origine forestale e arborea contenuto nel prodotto). Una foresta PEFC è una foresta gestita in linea con i più severi requisiti ambientali, sociali ed economici. Una foresta che ci sarà anche per le generazioni future.

Pelle

Bolzan Letti utilizza esclusivamente pelli di alta qualità, provenienti da concerie selezionate e prodotte con trattamenti che rispettano l'ambiente. Il fascino e il prestigio naturali di questa materia prima, capace di donare emozioni uniche al tatto e alla vista, sono ulteriormente valorizzate da un controllo di qualità accurato che oltre all'utilizzo di moderne tecnologie, prevede l'intervento di occhi e mani esperte, per scartare tutte le parti non idonee alle lavorazioni e garantire un risultato finale perfetto.

Imballo

Un'attenzione particolare è riservata al packaging sostenibile. Ridurre all'essenziale per diminuire la quantità di rifiuti o utilizzare materiali naturali, biodegradabili e riciclabili è diventato un elemento importante per Bolzan Letti, che vede la sostenibilità come un valore aggiunto dei propri prodotti. Bolzan Letti ha abbandonato plastiche e polistirolo a favore degli imballaggi in cartone 100% riciclabile: cartone semplice e a nido d'ape. Le scatole contenitive sono inoltre realizzate da un nuovo macchinario che prepara imballi ad hoc a seconda delle dimensioni del prodotto riducendo al minimo gli sprechi. Per trasporti internazionali vengono utilizzati anche imballaggi in legno per proteggere al meglio il prodotto Bolzan.

Wood

All wood comes from certified PEFC/CTM producers, which means that wood comes from reforestation plantations, where every used tree is replaced by a new one to avoid destroying the environment and thus increasing its oxygen supply to the atmosphere.

Thanks to its deep attention to environmental policy and the pursuit of new objectives for the improvement of its product, especially in terms of the protection of human health, Bolzan Letti has already chosen to go further, buying only CARB e CARB2 certified plywood panels, for all production and not only for products to be placed on the US market.

100% recyclable aluminium

Aluminium is resistant, lightweight and durable. Its features do not change over time and allow it to be recycled infinitely, with a limited energy consumption, and without risking the loss of its original characteristics. That is the reason why it can be defined the eco friendly material for excellence, and represents the beginning of a better quality of life for future generations.

The foam rubber and the inner lining

From the clever cutting of the foam blocks all the paddings are formed. In the paddings it is essential to know how to use different foam densities as each part of the bed responds to different aesthetic-functional requirements. The use of high-density and non-deformable polyurethane foam guarantees comfort and durability. All the padded parts are lined with dacron coupled with flame retardant and light resistant velfodera (fibre-lining), according to world standard laws.

Recycled / recyclable materials

Attention was also paid to the padding, made mainly of recyclable foams. The flexible polyurethane foam, commonly known as "foam rubber", represents the most widely used padding, thanks to its wide availability for sizes and densities. The surplus are reconverted into expanded agglomerate slabs that are entirely reused within our production, thus eliminating raw material waste.

Non-toxic glues

We use water-based glue to reduce the presence of synthetic solvents. The advantages of using this water-based stain in it's great sustainability and limited environmental impact. Thanks to the use of water-based components, it is in fact possible to reduce the emissions of volatile organic compounds (VOCs) by 95 percent, compared to the use of common solvent-based paints. Another advantage related to their use is that these products are completely odorless, non-flammable and characterized by extremely limited toxicity levels.

Alternative materials / coconut

The continuous research and the will to innovate in a sustainable way led the company to use alternative materials such as the coconut slabs to make up the padding of the bed. Coconut fibers are impregnated with natural latex: the resulting amalgam (the rubberized coconut) is vulcanized and subsequently shaped into slabs of various sizes, thicknesses and densities. It is also possible to have shaped slabs with transverse channels to favor further breathability.

Compared to other materials, the use of coconut in the processing of upholstered furniture has the advantage of an easy and quick product packaging, since the rubberized coconut sheets can be glued, stapled and sewn while maintaining their main characteristic which is the same: robustness: they do not flake off over time, do not cause dust, do not absorb moisture. In addition, it is suitable to be used inside armchairs and mattresses, reaching 20% less weight.

Alternative materials / wadding

The wadding helps to ensure the well-being of the person during rest, remaining in contact with the body together with the fabric and creating a pleasant sensation of comfort. Bolzan Letti pays the same attention to this material as it does to the construction of inner structures. The wool wadding has a microstructure formed by a dense network of fibers giving the padding natural qualities of breathability, non-deformability and durability. Polyester wadding is not only a soft, non-deformable, resistant, hypoallergenic material, resistant to mites and molds and water-repellent, but also eco-sustainable. In fact, it is usually made up of 75% fibers from the recycling of plastic bottles and is therefore easily recyclable.

Fabrics

Sustainable fabrics are the result of environmentally friendly industrial production processes, based on the reduction of energy consumption, on the use of renewable raw material sources, and on the optimization of the production chain capable of reducing the use of chemical products also thanks to new solutions based on biochemistry and the use of biotechnology.

- **FSC fabrics** Numerous fabrics from the Bolzan collection are FSC branded. These fabrics are more environmentally friendly than synthetic fibers or cotton since the cellulose fibers they are made of come from forests that are managed correctly and sustainably.

- **OEKO fabrics** The Oeko-Tex Standard 100 is a globally uniform testing and certification system for textile raw materials, intermediate and end products at all stages, which allows to identify those products that do not present any risk to the health of the consumer.

- **PEFC fabrics** The PEFC mark means that the good comes from a certified forest (obviously, only the material of forest and arboreal origin contained in the product). A PEFC forest is a forest managed in line with the strictest environmental, social and economic requirements. A forest that will also be there for future generations.

Leather

Bolzan Letti uses only high quality leathers, from selected tanneries and produced with treatments that respect the environment. The natural charm and prestige of this raw material, capable of giving unique emotions to the touch and sight, are further enhanced by an accurate quality control which, in addition to the use of modern technologies, involves the intervention of expert eyes and hands, to discard all parts not suitable for processing and guarantee a perfect final result.

Packaging

Special attention is paid to sustainable packaging. Reducing it to the essential to decrease the amount of waste or the use of natural, biodegradable and recyclable materials has become an important element for Bolzan, which sees sustainability as an added value to its product system. Bolzan Letti has abandoned plastics and polystyrene in favor of 100% recyclable cardboard packaging. For all packaging there is the exclusive use of simple and honeycomb cardboard, instead of polymeric materials such as polystyrene. The containment boxes are also made from a new machine preparing ad hoc packaging according to the product size, thus waste is minimized. For international transport, wooden packaging is also used to better protect Bolzan products.