Manhattan

laCividina

Family

Armchair / Sofa / Dormeuse /
Ottoman / System

Designer

Fulvio Bulfoni / 1996



+61 8 9389 6669
info@henriliving.com.au
245 Stirling Hwy, Claremont WA 6010
www.henriliving.com.au

Henri

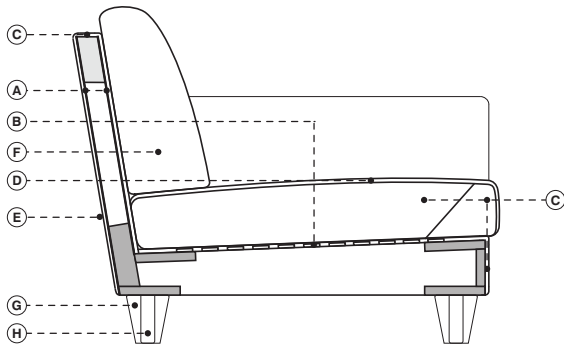

| | | | |
|--|---|--|--|
| ■ Legno massiccio di abete | ■ Solid fir | ■ Bois de sapin massif | ■ Massivholz aus Tanne |
| ■ Legno massiccio di faggio | ■ Solid beech | ■ Bois de hêtre massif | ■ Massivholz aus Buche |
| A. Pannello di masonite | A. Masonite panels | A. Panneau de particules | A. Holzfaserplatte |
| B. Cinghie elastiche ad alta densità | B. High density elastic straps | B. Sangles élastiques | B. Elastischen Gurtbändern |
| C. Poliuretano espanso ignifugo indeformabile a quote differenziate | C. Flame-retardant undeformable polyurethane foam of different densities | C. Mousse polyuréthane expansé ignifuge indéformable à épaisseurs différenciées | C. Feuerfester formbeständige Polyurethanschaum in unterschiedlicher Dichte |
| D. Fibra di poliestere | D. Polyester fibers | D. Fibre de polyester | D. Polyester |
| E. Rivestimento sfoderabile in tessuto e non sfoderabile in pelle e finta pelle | E. Removable upholstery in fabric and fixed in leather or artificial leather | E. Revêtement déhoussable en tissu et pas déhoussable en cuir ou simili cuir | E. Abziehbarer Bezug aus Stoff oder unabziehbarer aus Leder und Kunstleder |
| F. Piuma e fibra di poliestere elicoidale | F. Feathers and helical polyester fibers | F. Plume et fibre de polyester hélicoïdale | F. Daunen und Polyesterfaser spiralförmig |
| G. Legno di faggio | G. Beech wood | G. Bois de hêtre | G. Buchenholz |
| H. Alluminio | H. Aluminium | H. Aluminium | H. Aluminium |

Note • Notes • Annotation • Anmerkung

| | | | |
|---|--|---|---|
| <ul style="list-style-type: none"> • Piedi personalizzabili con tinta cliente • Prodotto disponibile su misura con preventivo su richiesta • Su richiesta attacco per connessione elettrica e USB con sovrapprezzo • Cuscini extra disponibili • COM: tessuto cliente (tinta unita e h.140 cm.) - campione richiesto • COL: pelle cliente - campione richiesto • CAT. SPECIAL: prezzo e disponibilità su richiesta | <ul style="list-style-type: none"> • Feet customizable with customer's colors on request • This item can be tailor made with price on request • Electrical connection and USB upon request with upcharge • Extra cushions available • COM: client's fabric (plain colour and width 140 cm.) - sample required • COL: client's leather - sample required • CAT. SPECIAL: price and availability on request | <ul style="list-style-type: none"> • Pieds personnalisable avec coloris du sur demande • Collection personnalisable sur demande • Sur demande connection électrique et USB avec surcoût • Autres coussins disponibles • COM: tissu fourni (couleur unie et hauteur 140 cm.) - échantillon nécessaire • COL: cuir fourni - échantillon nécessaire • CAT. SPECIAL: prix et disponibilité sur demande | <ul style="list-style-type: none"> • Füße in Kundenfarben auf Anfrage verfügbar • Produkt nach Maß verfügbar auf Anfrage • Elektrische Verbindung und USB-Anschluss auf Anfrage gegen Aufpreis • Weitere Kissen verfügbar • COM: Kundenstoff (einfarbig und Breite 140 cm.) - Stoffmuster nötig • COL: Kundenleder - Ledermuster nötig • CAT. SPECIAL: Preis und Verfügbarkeit auf Anfrage |
|---|--|---|---|

Finiture in legno • Wooden finishes • Finitions bois • Holzausführungen



Faggio naturale
Natural beech
Hêtre naturel
Buchenholz Naturfarbe



Faggio tinto noce
Walnut-stained beech
Hêtre teinté noyer
Buchenholz Nussbaum gebeizt



Alluminio lucido
Polished aluminum
Aluminium brillant
Poliert Aluminium



Alluminio opaco
Matt aluminum
Aluminium mat
Aluminium matt

Opzione • Option • Option • Opzion



Su richiesta attacco per connessione elettrica e USB con sovrapprezzo
Electrical connection and USB upon request with upcharge
Sur demande connection électrique et USB avec surcoût
Elektrische Verbindung und USB-Anschluss auf Anfrage gegen Aufpreis

Sistema di aggancio • System connector • Systeme d'assemblage • Verbindungshaken



Sistema di aggancio tra elementi
Components connector
Systeme d'assemblage de socle
Verbindungssystem zwischen Elemente

Rivestimenti consigliati • Recommended coverings • Revêtements conseillées • Empfohlene Bezüge

| | | | |
|-------------------------|----------------------------|------------------------------|----------------------------|
| • cat. A XTREME | • cat. C TREND | • cat. extra MOLLY | • cat. lux LUX 1 |
| • cat. A STEP | • cat. C SUPERB | • cat. extra RIME | • cat. lux LUX 2 |
| • cat. A ANGEL | • cat. C UMAMI | • cat. extra STEELCUT TRIO 3 | • cat. imperial IMPERIAL 1 |
| • cat. A MEDLEY | • cat. C HESTAN | • cat. extra ARIANA | • cat. imperial IMPERIAL 2 |
| • cat. A MOOD | • cat. C DEANS | • cat. extra COLLINE | • cat. imperial NABUK |
| • cat. A CRAZY | • cat. super REMIX 2 | • cat. extra OPERA | • cat. special DROP |
| • cat. B EXTREMA | • cat. super CAPTURE | • cat. extra DANTE | |
| • cat. B IKON | • cat. super MODA | • cat. extra ARCO | |
| • cat. B SILVERTEX | • cat. super REVIVE 1 | • cat. maxi HALLINGDAL 65 | |
| • cat. B SAMAR | • cat. super BREEZE FUSION | • cat. maxi COMFORT | |
| • cat. B FAME | | • cat. maxi DIVINA 3 | |
| • cat. B MAIN LINE FLAX | | | |

cod. 5100 / armchair

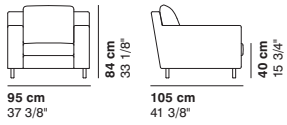

cod. 5102 / 2 seater

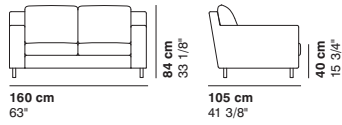

cod. 5103 / 2 seater major

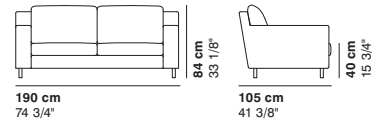

cod. 5104 / 3 seater

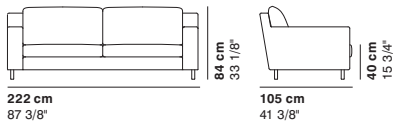

cod. 5105 / 3 seater major

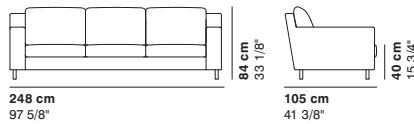

cod. 5106 / corner

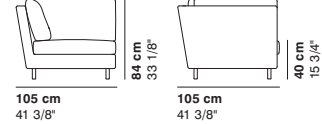

cod. 5107 / element 70

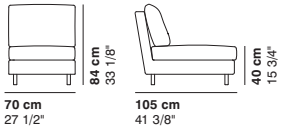

cod. 5108 / right element 86

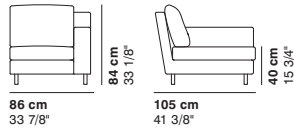

cod. 5109 / left element 86

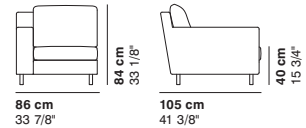

cod. 5110 / right element 144

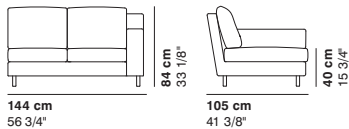

cod. 5111 / left element 144

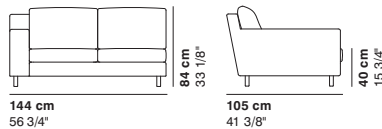

cod. 5112 / right element 206

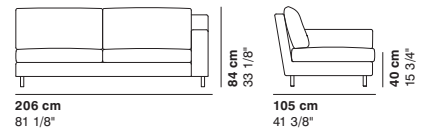

cod. 5113 / left element 206

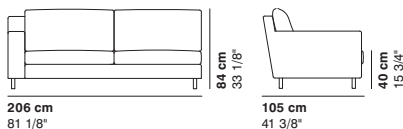

cod. 5114 / right small dormeuse

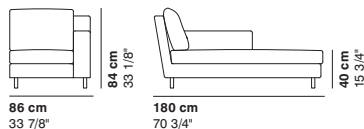

cod. 5115 / left small dormeuse

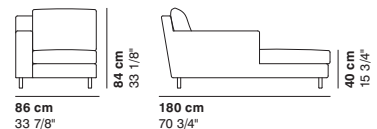

cod. 5116 / right big dormeuse

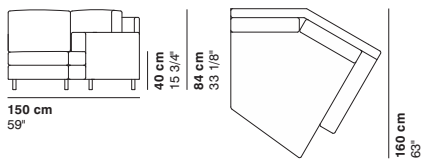

cod. 5117 / left big dormeuse

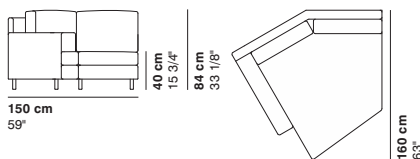

cod. 5118 / ottoman 60

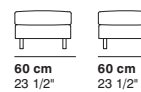

cod. 5119 / ottoman 100

