

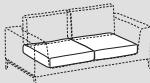

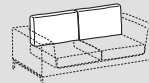



Pacific

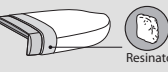

	 Seduta - Seat	 Schienali - Backrests		
Rivestimento Upholstering (8)	Sfoderabile Removable  	Sfoderabile Removable  		
	Non sfoderabile Not removable —	Non sfoderabile Not removable —		
Imbottiture Padding (3-4-5-6)	 D.30/40/45kg/m³	 lastre D.21/30kg/m³		

INFORMAZIONI TECNICHE

Struttura: 1

Masselli portanti in legno di abete. Elementi strutturali in pannelli di legno multistrati in classe E1, tamponamenti in faesite.

Molleggio: 1-2

Schienale in pannello di faesite. Seduta in nastri elastici di fibra propilenica e lattice incrociati e meccanicamente pretensionati.

Note:

Non disponibile rivestimento in tessuto Like.

TECHNICAL INFORMATION

Structure: 1

Solid fir wood. Structural elements in multilayer wood panels in class E1, infills in faesite.

Springing: 1-2



The back is made of hardboard panels. Seat with pre-tensioned crossed propylene fibre and latex elastic webbing.

Note:

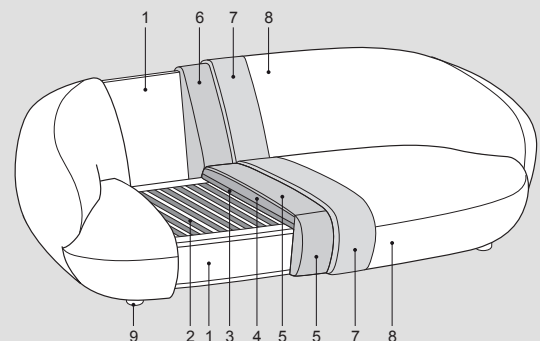
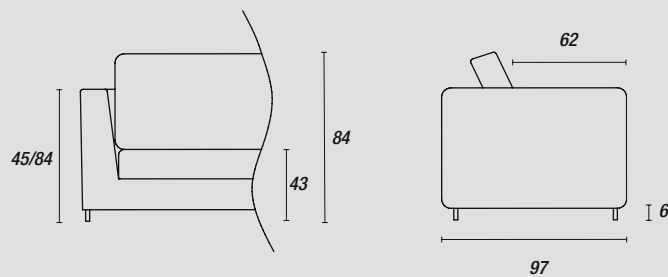
Upholstering in fabrics Like not available.



Piedini - Feet:

di serie	optional Pacific
	
H.6cm	H.6cm
Eucalipto (LE05)	con maggiorazione Light brown (ME11)